

RoHS COMPLIANT

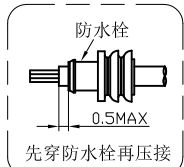

P1

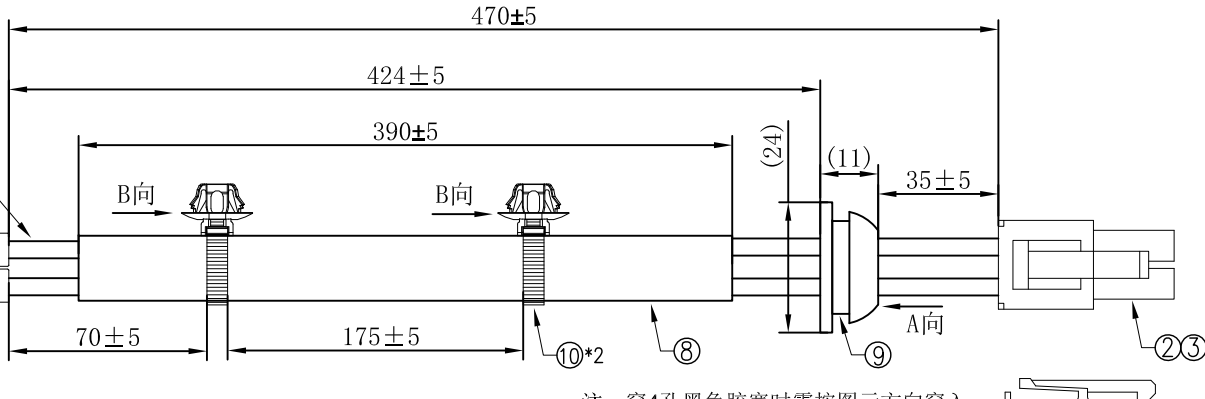
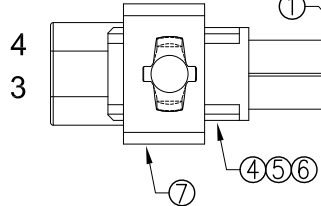
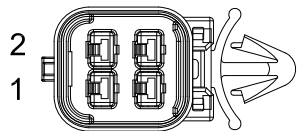

P2

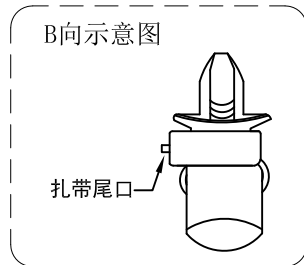
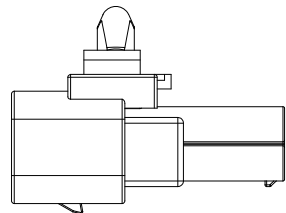
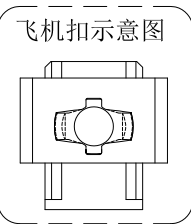
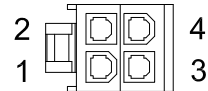

注：穿4孔黑色胶塞时需按图示方向穿入，不可反穿。

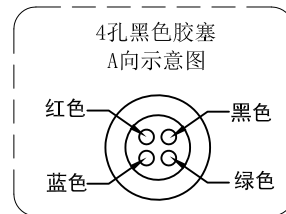

⑩	Other	黑色椭圆蘑菇头扎带	2	pcs
⑨	Other	4孔 黑色胶塞	1	pcs
⑧	Tube	Ø8.0 黑色PVC套管	1	pcs
⑦	Other	368260-1 飞机扣	1	pcs
⑥	Other	368933-1 防水栓	4	pcs
⑤	Terminal	936612-1 Terminal	4	pcs
④	Housing	936293-2 Housing 2*2P	1	pcs
③	Terminal	MX4.2 母 Terminal	4	pcs
②	Housing	MX4.2 公 Housing 2*2P	1	pcs
①	Wire	UL3398 16AWG	4	pcs
NO.	Material	Description	Q'TY	Unit

WIRE LIST

P1	Color	P2	Remark
1	红色	1	
2	黑色	2	
3	蓝色	3	
4	绿色	4	

注意事项:

- 100%短路、断路、错位等测试。
- 导通阻抗:5Ω/Max.
- 线材表面干净，无破损、脏污等不良。
- ()内为参考尺寸。
- 每批次须做切片分析，压缩比：80%~90%，使用专用刀片。

F	A4				TITLE:	DRAWN: 郑爱华 2024.06.28	KONNRA 东莞市康瑞电子有限公司 DongGuan Konnra Electronics Co.,Ltd.		
	A3				936293-2 HSG 2*2P TO MX4.2 公 HSG 2*2P L=470mm	CHECKED:			
	A2					APPROVED:			
MARK	REVISION DESCRIPTION	SIGNATURE	DATE	UNIT:mm	SCALE:N/A	SHEET:1/1	PROJECTION	REV.:A1	DRAWING NO.:XHZ10022263S
1	2	3	4	5	6	7	8	9	