

RoHS
COMPLIANT

SPECIFICATIONS

1. Current rating: 3A AC, DC
2. Voltage rating: 250V AC,DC
3. Temperature range: -40°C ~ +105°C
4. Insulation resistance: 1000MΩ Min.
5. Withstanding voltage: 800V AC/ minute.
6. Contact resistance: 20mΩ Max.

Material:

Insulator: Nylon 66 UL 94V-0
 Contact: Brass
 Plating: Tin plated over Nickel
 Mate with KR2504 series Housing
 Ordering Code:



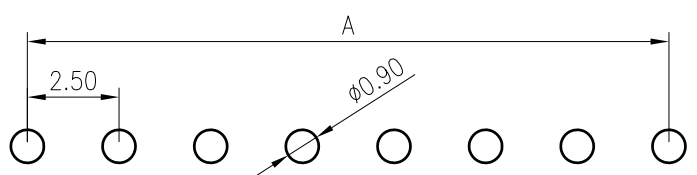
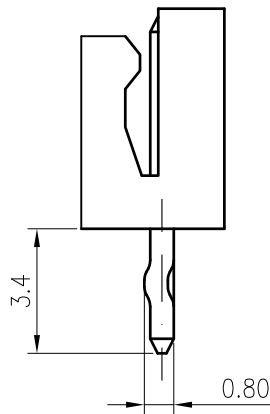
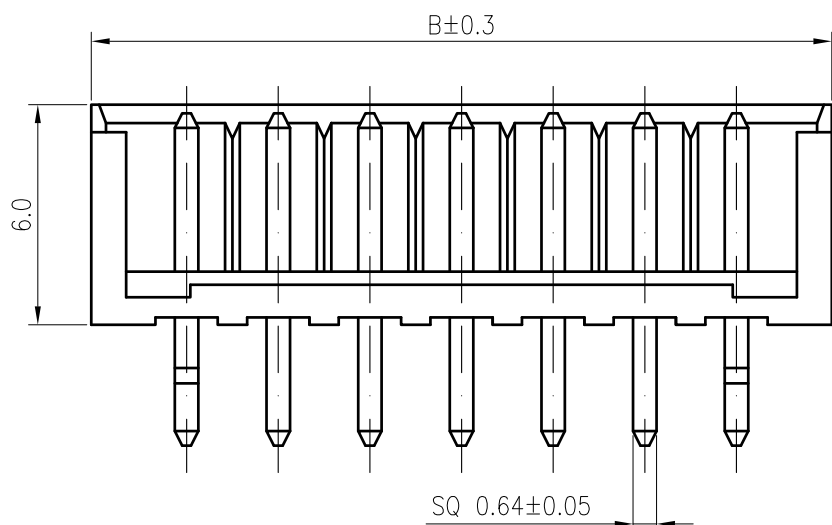
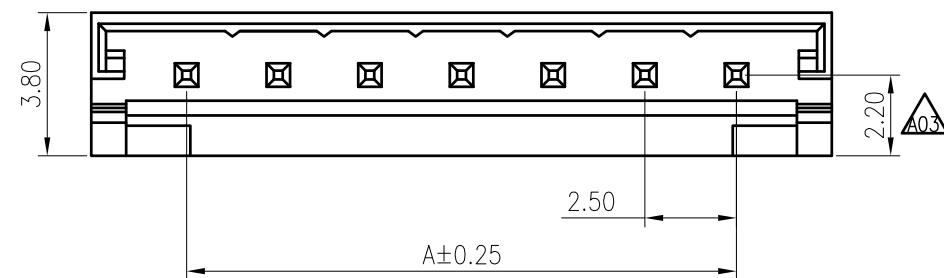

 C2504VD *** 01 T01 01 PA

No.of Circuits
 102:2,116:16

Circuits	Dimension	
	A	B
2	2.50	7.50
3	5.00	10.00
4	7.50	12.50
5	10.00	15.00
6	12.50	17.50
7	15.00	20.00
8	17.50	22.50
9	20.00	25.00
10	22.50	27.50
11	25.00	30.00
12	27.50	32.50
13	30.00	35.00
14	32.50	37.50
15	35.00	40.00
16	37.50	42.50



Recommend P.C.B. LAYOUT

F		Modify Size	ZSZ	2024.09.02	TOLERANCE X.X ±0.30 X.XX ±0.20 X.XXX ±0.10 Angle ±2°	TITLE: EH2.5 DIP 180° Wafer	DRAWN: ZSZ 2024.09.02		KONNRA 东莞市康瑞电子有限公司 DongGuan Konnra Electronics Co.,Ltd.
		Add Dimensions	ZSZ	2023.9.27			CHECKED:		
		Change the part number and frame format	LJT	2020.05.05			APPROVED:		
MARK	REVISION DESCRIPTION	SIGNATURE	DATE	UNIT:mm	SCALE:N/A	SHEET:1/1	PROJECTION 	REV.:A04	DRAWING NO.:2504WVD101-A-S
1	2	3	4	5	6	7	8	9	