

RoHS
COMPLIANT

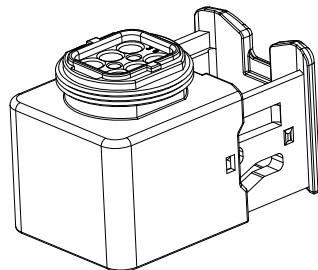
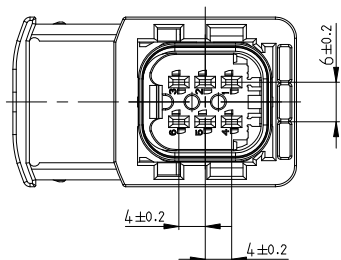

SPECIFICATIONS

1. Current rating: 3A AC, DC
2. Temperature range: -40°C ~ +140°C
3. Insulation resistance: 1000MΩ min.
4. Withstanding voltage: 500V AC/ minute.
5. Contact resistance: 5mΩ max.

CODING A

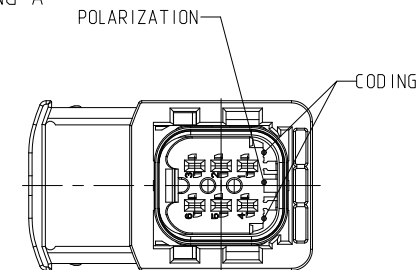

CODING B

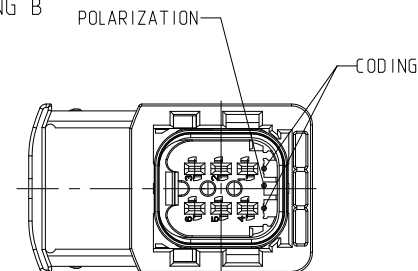

CODING C

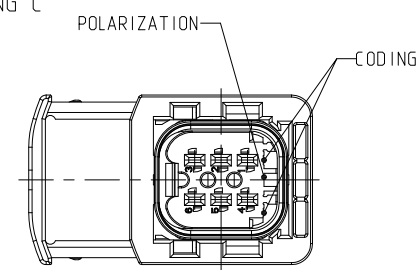

CODING D

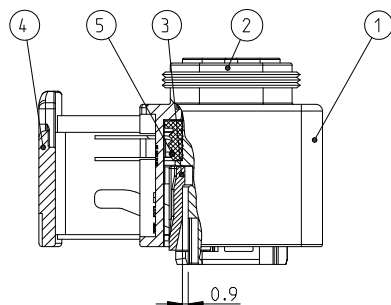
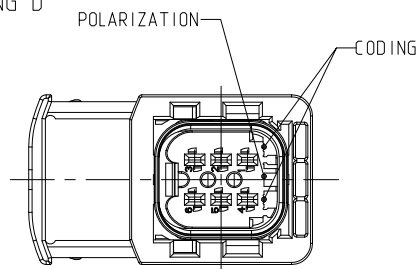

SECTION A-A

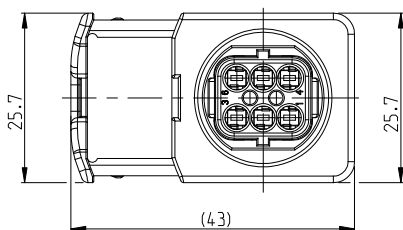
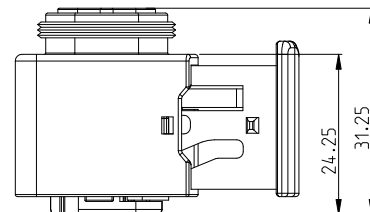
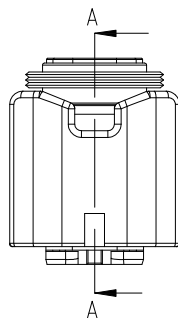

PBT-GF30 / V-0	BLACK	RECEPTACLE HOUSING	1
PBT-GF30 / V-0	BLACK	6POS. CAVITY BLOCK, CODE. "A"	2
PBT-GF30 / V-0	GREY	6POS. CAVITY BLOCK, CODE. "B"	2
PBT-GF30 / V-0	GREEN	6POS. CAVITY BLOCK, CODE. "C"	2
PBT-GF30 / V-0	BLUE	6POS. CAVITY BLOCK, CODE. "D"	2
PBT-GF30 / V-0	YELLOW	SECONDARY LOCKING DEVICE	3
PBT-GF30 / V-0	YELLOW	U-SLIDE	4
VMQ	WHITE	SEAL	5
MATERIAL	COLOUR	DESCRIPTION	ITEM NO



MARK

REVISION DESCRIPTION

SIGNATURE

DATE

TOLERANCE

X.X ±0.30
X.XX ±0.20
X.XXX ±0.10
Angle ±2°

TITLE:

Pitch 4.0 2X3P
Socket Housing
H=31.25

UNIT:mm

SCALE:1:1

DRAWN: *LCC 2024.07.25*

CHECKED:

APPROVED:

SHEET:1/1

PROJECTION

KONNRA 东莞市康瑞电子有限公司
DongGuan Konnra Electronics Co.,Ltd.

PART NO.:H4005F2030501A

REV.:A01 DRAWING NO.:4005H201-A-S

1

2

3

4

5

6

7

8

9