

RoHS
COMPLIANT

SPECIFICATIONS

1. Current rating: 3A (AWG #24)AC, DC
2. Voltage rating: 100V AC,DC
3. Temperature range: -40°C ~ +125°C
4. Insulation resistance:500MΩ Min.
5. Withstanding voltage: 500V AC/ minute.
6. Contact resistance: 25mΩ Max.

Material: PBT UL94 V-0
Suitable: KR1507 series terminal
Mate with KR1507 series wafer

Ordering Code:

H15070 *** 24 02A

No.of Circuits
102:02,
115:15
Insulator Material
24:PBT White

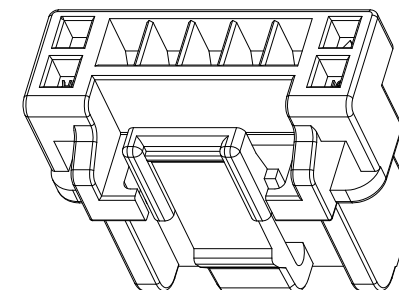
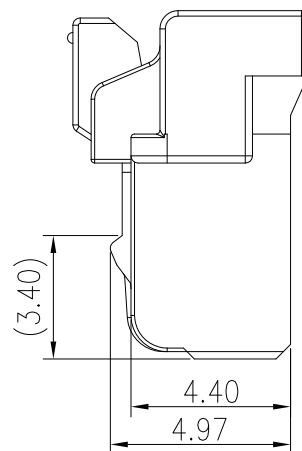
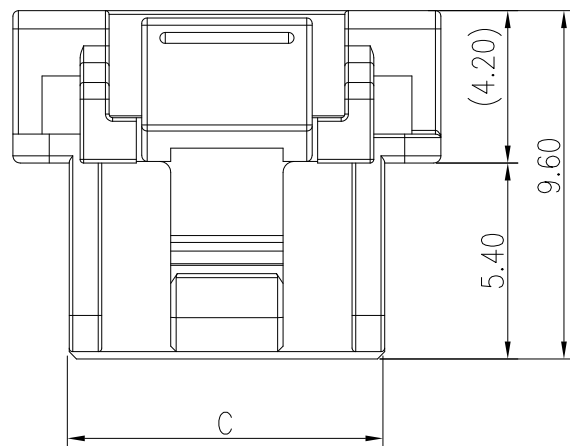
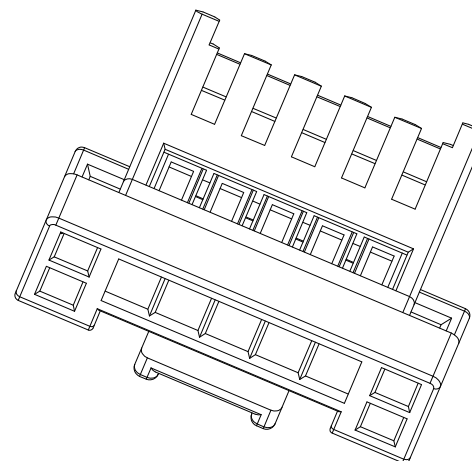
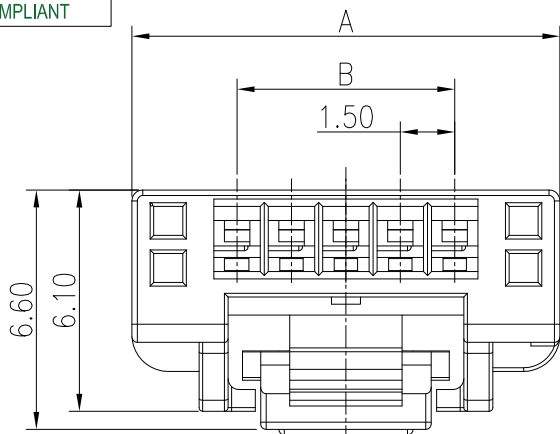

15P	26.80	21.00	23.70
14P	25.30	19.50	22.20
13P	23.80	18.00	20.70
12P	22.30	16.50	19.20
11P	20.80	15.00	17.70
10P	19.30	13.50	16.20
9P	17.80	12.00	14.70
8P	16.30	10.50	13.20
7P	14.80	9.00	11.70
6P	13.30	7.50	10.20
5P	11.80	6.00	8.70
4P	10.30	4.50	7.20
3P	8.80	3.00	5.70
2P	7.30	1.50	4.20
Circuits	A	B	C

△A03				TOLERANCE	TITLE:	DRAWN: <i>liu 2023.11.28</i>	KONNRA 东莞市康瑞电子有限公司	
△A02				X.X ±0.30	MX1.5 Inner buckle	CHECKED:	DongGuan Konnra Electronics CO.,LTD	
△A01	NEW	LIU	2023.11.28	X.XX ±0.20	Housing	APPROVED:	PART NO.: H151101**2401A	
LTR	REVISION DESCRIPTION	SIGNATURE	DATE	X.XXX ±0.10	UNIT:mm	SHEET:1/1	PROJECTION	VER.:A01
				Angle ±3°	SCALE:1/1			DRAWING NO.:1511H101-A-S

RoHS
COMPLIANT

SPECIFICATIONS

1. Current rating: 3A AC, DC
2. Voltage rating: 250V AC,DC
3. Temperature range: -40°C ~ +125°C
4. Insulation resistance: 1000MΩ/ min.
5. Withstanding voltage: 500V AC/ minute.
6. Contact resistance: 25mΩ/ max.

Material: PBT
Suitable: KR1507 series HSG
Mates With KR1507 Series Wafer

Ordering Code:

H150701** ** 11A

102=1*2P

103=1*3P

....

Insulator Material
24:PBT White

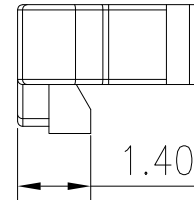
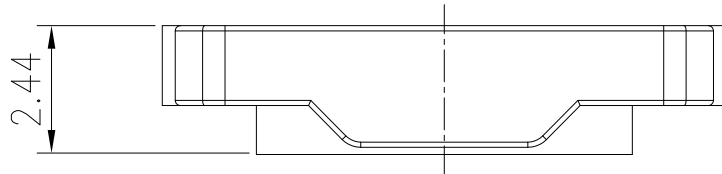
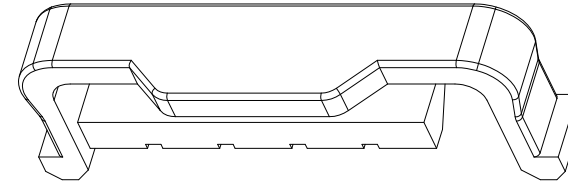
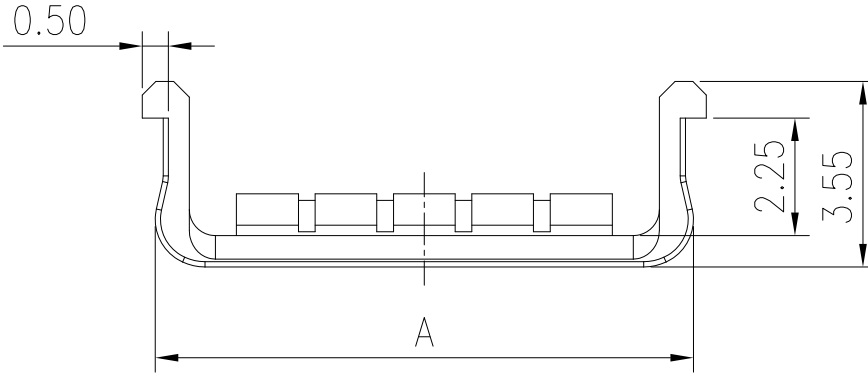

15P	25.30
14P	23.80
13P	22.30
12P	20.30
11P	19.30
10P	17.80
9P	16.30
8P	14.80
7P	13.30
6P	11.80
5P	10.30
4P	8.80
3P	7.30
2P	5.80
Circuits	A

F	A03				TOLERANCE	TITLE:	DRAWN: <i>WESLEY</i> 2023.10.20	KONNRA 东莞市康瑞电子有限公司		
	A02				X.X ±0.30	MX1.5 TPA	CHECKED:	DongGuan Konnra Electronics Co.,Ltd.		
	A01	NEW	Liu	2023.11.28	X.XX ±0.20		APPROVED:	PART NO.: H151101**0211A		
	MARK	REVISION DESCRIPTION	SIGNATURE	DATE	X.XXX ±0.10	UNIT:mm	SCALE:N/A	SHEET:1/2	PROJECTION	REV.:A01
	1	2	3	4		5	6	7	8	9

RoHS
COMPLIANT

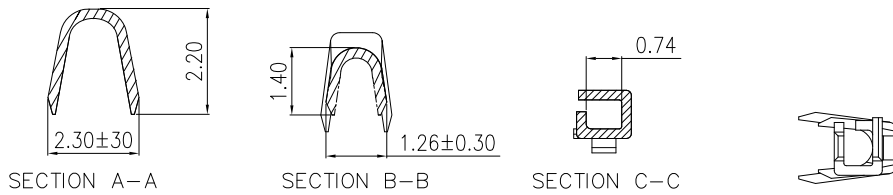
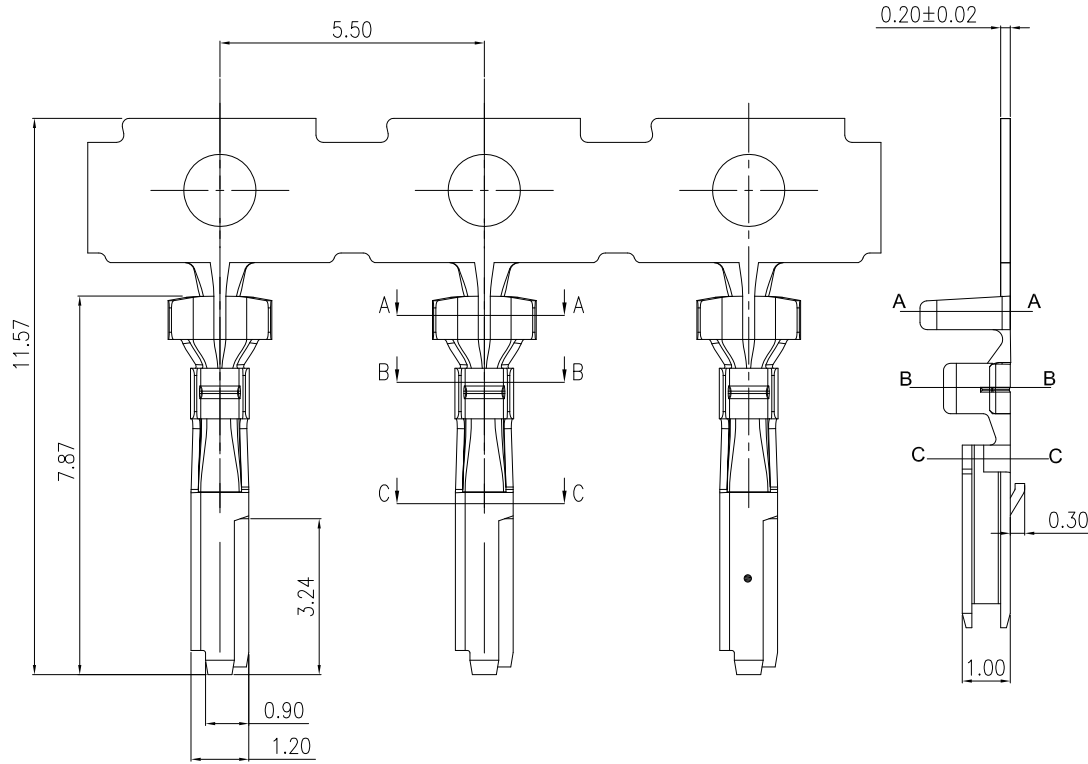

SPECIFICATIONS

1. Current rating: 3A (AWG #24)AC, DC
2. Voltage rating: 100V AC,DC
3. Temperature range: -40°C ~ +125°C
4. Insulation resistance:500MΩ Min.
5. Withstanding voltage: 500V AC/ minute.
6. Contact resistance: 25mΩ Max.

Material: Phosphor Bronze

Finish: TIN plated over Nickel

Applicable wires: AWG #24~#28

Insulation O.D 0.78~1.28 mm

Qty/reel: 10,000 PCS

F	△A03				TOLERANCE	TITLE:	DRAWN:	KONNRA 东莞市康瑞电子有限公司 DongGuan Konnra Electronics CO.,LTD		
	△A02				X.X ±0.30	MX1.5 Inner buckle Terminal	CHECKED:			
	△A01	NEW	LIU	2023.11.28	X.XX ±0.20		APPROVED:	PART NO.:T15110PT0101A		
	LTR	REVISION DESCRIPTION	SIGNATURE	DATE	X.XXX ±0.10	UNIT:mm	SCALE:1/1	SHEET:1/1	PROJECTION	VER.:A01
	1	2	3	4	5	6	7	8	9	

RoHS
COMPLIANT

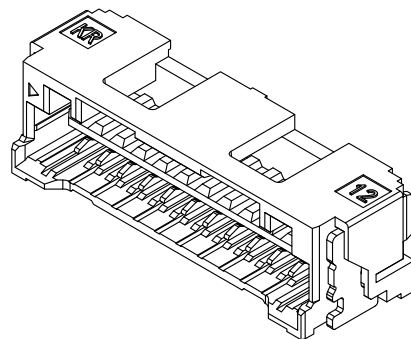
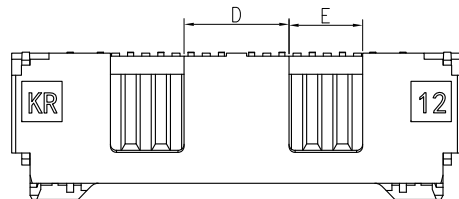

SPECIFICATIONS

1. Current rating: 3A (AWG #24)AC, DC
2. Voltage rating: 100V AC,DC
3. Temperature range: -40°C ~ +105°C
4. Insulation resistance:500MΩ Min.
5. Withstanding voltage: 500V AC/ minute.
6. Contact resistance: 20mΩ Max.

Material:

Insulator: PA9T UL 94V-0

Pin: Phosphor bronze

Fitting Nail: Brass

Plating: Tin plated over Nickel

Mate with KR1507 series Housing

PART NO:

C1507VS1**11M0101RA

02: 2P

16: 16P

11: PA9T Natural

M01: Matte Tin

R: Reel
P: Bag

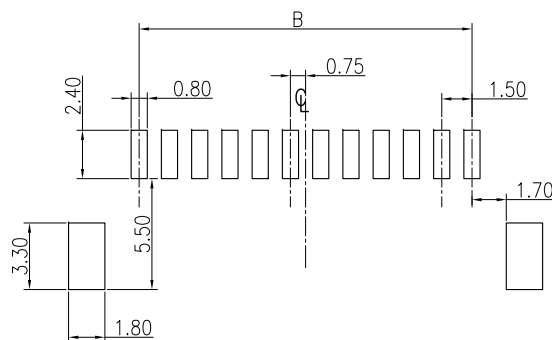
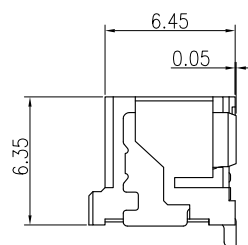
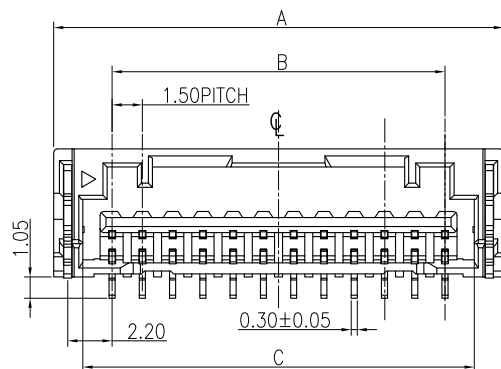

Recommended P.C.B. Layout
Total tolerance:±0.05mm

15P	26.80	21.00	23.90	5.20	3.65	
14P	25.30	19.50	22.40	5.20		
13P	23.80	18.00	20.90	5.20		
12P	22.30	16.50	19.40	5.20		
11P	20.80	15.00	17.90	5.20		
10P	19.30	13.50	16.40	3.20		
9P	17.80	12.00	14.90	3.20		
8P	16.30	10.50	13.40	2.50		3.25
7P	14.80	9.00	11.90	2.50		2.50
6P	13.30	7.50	10.40	2.30		2.15
5P	11.80	6.00	8.90	—	3.60	
4P	10.30	4.50	7.40	—	3.30	
3P	8.80	3.00	5.90	—	2.55	
2P	7.30	1.50	4.40	—	1.85	
PIN	A	B	C	D	E	

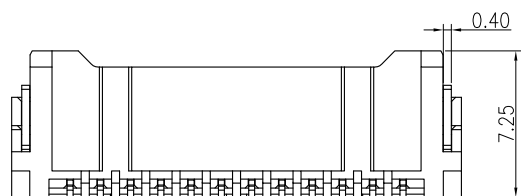

Uniformly arrange the drawings

Shen

2021.09.08

TOLERANCE

X.X ±0.30

X.XX ±0.20

X.XXX ±0.10

Angle ±2°

TITLE:

MX1.5 SMT 180°
INNER BUCKLE WF

DRAWN: Shen 2021.09.08

CHECKED:

APPROVED:

KONNRA 东莞市康瑞电子有限公司
DongGuan Konnra Electronics Co.,Ltd.

PART NO.:C1507VS1**11M0101RA

MARK

REVISION DESCRIPTION

SIGNATURE

DATE

UNIT:mm

SCALE:1/1

SHEET:1/2

PROJECTION

REV.:A4

DRAWING NO.:1507WVS101-A-S

1

2

3

4

5

6

7

8

9

RoHS
COMPLIANT

2P VIEW

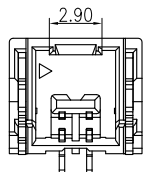

3P VIEW

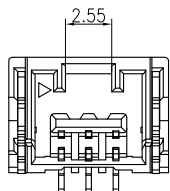

4P VIEW

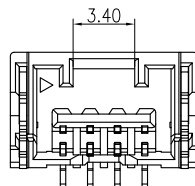

5P VIEW

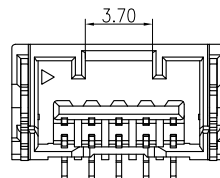

6P VIEW

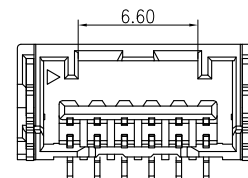

7P VIEW

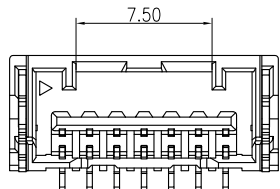

8P VIEW

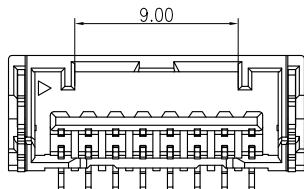

9P VIEW

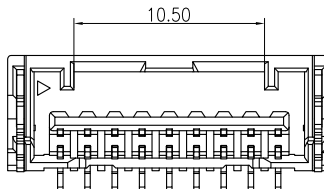

10P VIEW

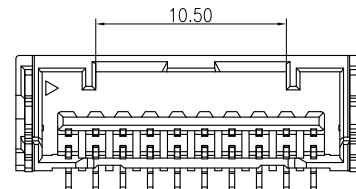

11P VIEW

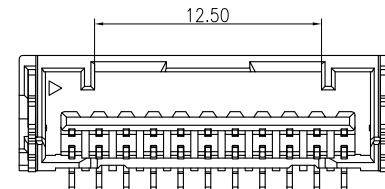

13P VIEW

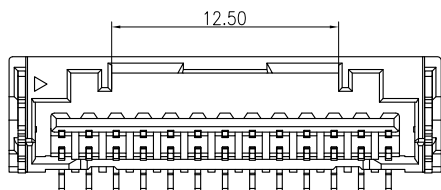

14P VIEW

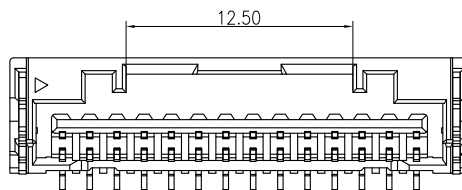

15P VIEW

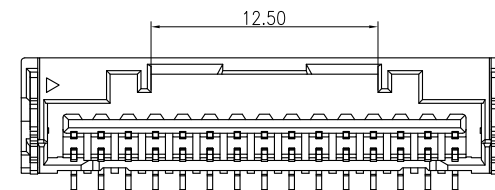

A3

Uniformly arrange the drawings

Shen

2021.09.08

TOLERANCE

X.X ±0.30

X.XX ±0.20

X.XXX ±0.10

Angle ±2°

TITLE:

MX1.5 SMT 180°
INNER BUCKLE WF

DRAWN: Shen 2021.09.08

CHECKED:

APPROVED:

KONNRA 东莞市康瑞电子有限公司

DongGuan Konnra Electronics Co.,Ltd.

PART NO.: C1507VS1**11M0101RA

MARK

REVISION DESCRIPTION

SIGNATURE

DATE

UNIT:mm

SCALE:1/1

SHEET:2/2

PROJECTION

REV.:A4

DRAWING NO.:1507WVS101-A-S

1

2

3

4

5

6

7

8

9

RoHS
COMPLIANT

SPECIFICATIONS

1. Current rating: 3A (AWG #24)AC, DC
2. Voltage rating: 100V AC,DC
3. Temperature range: -40°C ~ +105°C
4. Insulation resistance:500MΩ Min.
5. Withstanding voltage: 500V AC/ minute.
6. Contact resistance: 20mΩ Max..

Material:

Insulator: PA9T UL 94V-0
Pin: Phosphor bronze
Fitting Nail: Brass
Plating: Tin plated over Nickel
Mate with KR1507 series Housing

PART NO: C1507RS1**11M0101RA

02: 2P
16: 16P
11:PA9T Natural
M01: Matte Tin
R: Reel
P: Bag

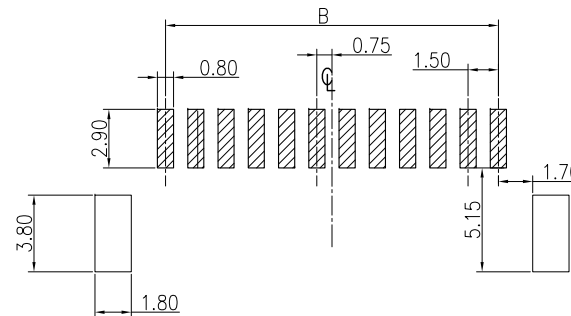
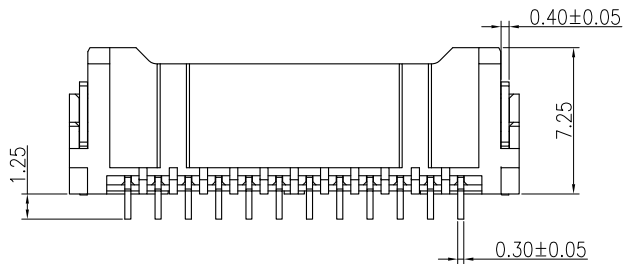
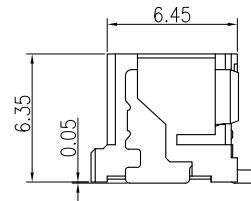
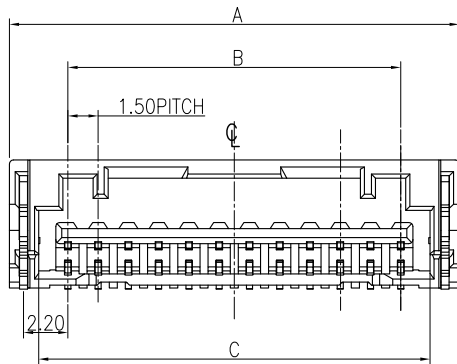
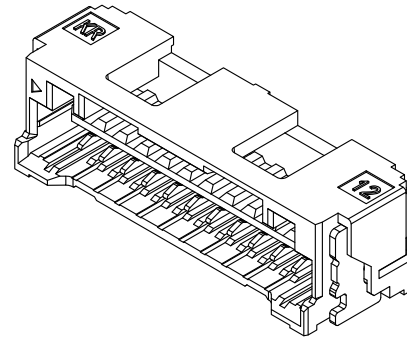
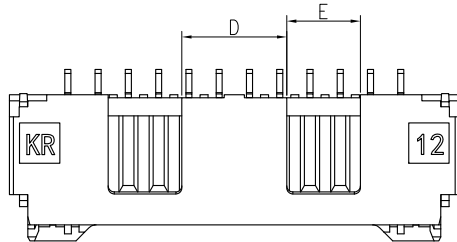

Recommended P.C.B. Layout
Total tolerance:±0.05mm

15P	26.80	21.00	23.90	5.20	3.65	
14P	25.30	19.50	22.40	5.20		
13P	23.80	18.00	20.90	5.20		
12P	22.30	16.50	19.40	5.20		
11P	20.80	15.00	17.90	5.20		
10P	19.30	13.50	16.40	3.20		
9P	17.80	12.00	14.90	3.20		
8P	16.30	10.50	13.40	2.50		3.25
7P	14.80	9.00	11.90	2.50		2.50
6P	13.30	7.50	10.40	2.30		2.15
5P	11.80	6.00	8.90	—	3.60	
4P	10.30	4.50	7.40	—	3.30	
3P	8.80	3.00	5.90	—	2.55	
2P	7.30	1.50	4.40	—	1.85	
PIN	A	B	C	D	E	

F		Uniformly arrange the drawings	Shen	2021.09.08	TOLERANCE X.X ±0.30 X.XX ±0.20 X.XXX ±0.10 Angle ±2°	TITLE: MX1.5 SMT 90° INNER BUCKLE WF	DRAWN: Shen 2021.09.28		KONNRA 东莞市康瑞电子有限公司					
		Change the table	Arvin	2020.11.20			CHECKED:		DongGuan Konnra Electronics Co.,Ltd.					
	MARK	REVISION DESCRIPTION	SIGNATURE	DATE			UNIT:mm	SCALE:1/1	SHEET:1/2	PROJECTION	REV.:A4	PART NO.:C1507RS1**11M0101RA		
	1	2	3	4			5	6	7	8	9	DRAWING NO.:1507WHS101-A-S		

RoHS
COMPLIANT

2P VIEW

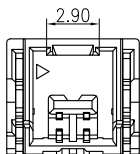

3P VIEW

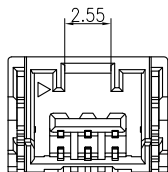

4P VIEW

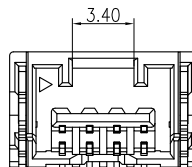

5P VIEW

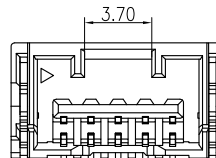

6P VIEW

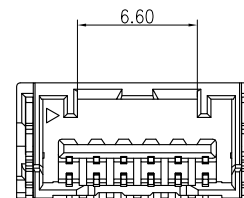

7P VIEW

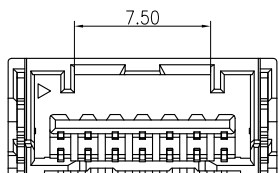

8P VIEW

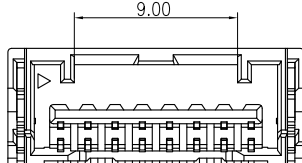

9P VIEW

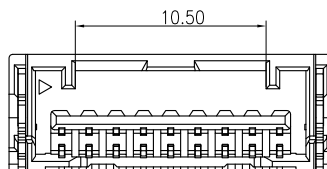

10P VIEW

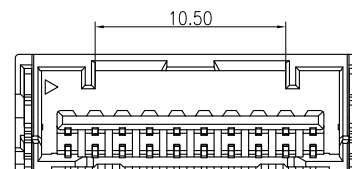

11P VIEW

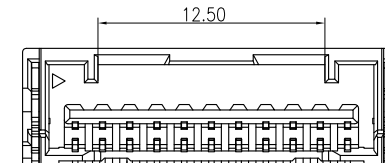

13P VIEW

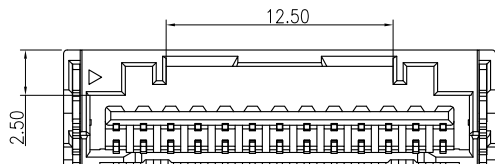

14P VIEW

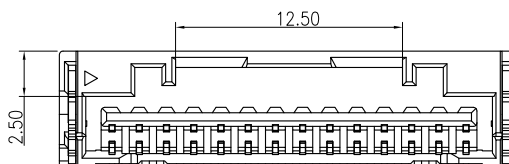

15P VIEW

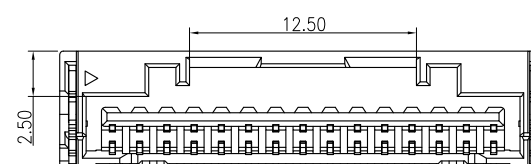

Uniformly arrange the drawings

Shen

2021.09.08

TOLERANCE

X.X ±0.30

X.XX ±0.20

X.XXX ±0.10

Angle ±2°

TITLE:

MX1.5 SMT 90°
INNER BUCKLE WF

DRAWN: Shen 2021.09.28

CHECKED:

APPROVED:

KONNRA 东莞市康瑞电子有限公司

DongGuan Konnra Electronics Co.,Ltd.

PART NO.: C1507RS1**11M0101RA

MARK

REVISION DESCRIPTION

SIGNATURE

DATE

UNIT:mm

SCALE:1/1

SHEET:2/2

PROJECTION

REV.:A4

DRAWING NO.:1507WHS101-A-S

1

2

3

4

5

6

7

8

9