





RoHS  
COMPLIANT

**SPECIFICATIONS**

1. Current rating: 5A AC, DC
2. Voltage rating: 250V AC,DC
3. Temperature range: -40°C ~ +105°C
4. Insulation resistance: 1000MΩ Min.
5. Withstanding voltage: 1500V AC/ minute.
6. Contact resistance: 10mΩ Max.



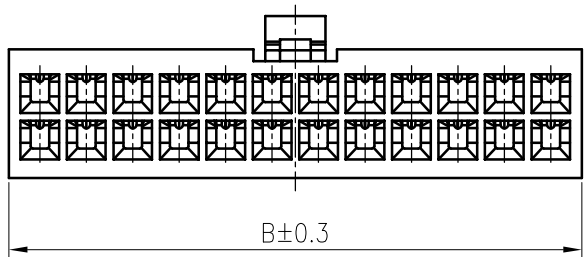
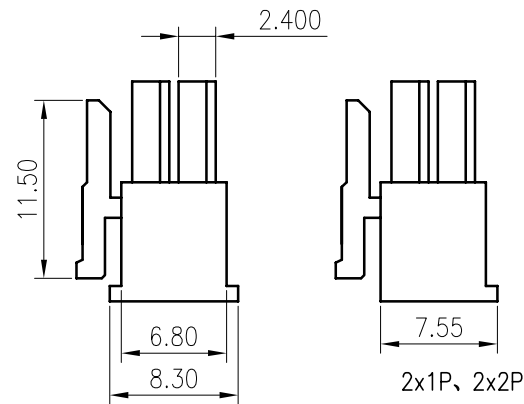
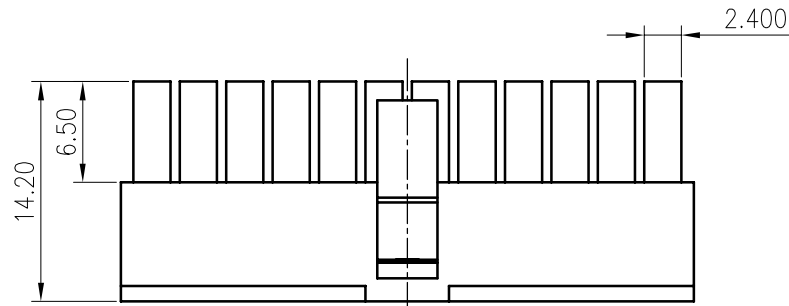
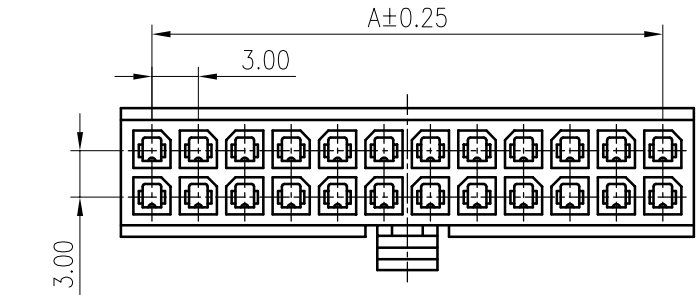

Material: PA66 UL94 V-0 or V-2  
 Circuits: 2\*2~2\*12  
 Suitable: KR3000HM series terminal  
 Mate With KR3000HF series dual row housing  
 and kr3000 series dual row wafer

Ordering Code:

H3000M \*\*\* \*\* 01A   
 No. of Circuits   
 201:2x1P,  
 202:2x2P.....  
 Insulator Material   
 02:PA66 UL94V-0 black   
 04:PA66 UL94V-2 black



Circuits	Dimensions	
	A	B
2*1P	/	5.50
2*2P	3.0	8.50
2*3P	6.0	10.00
2*4P	9.0	13.00
2*5P	12.0	16.00
2*6P	15.0	19.00
2*7P	18.0	22.00
2*8P	21.0	25.00
2*9P	24.0	28.00
2*10P	27.0	31.00
2*11P	30.0	34.00
2*12P	33.0	37.00

F					TOLERANCE	TITLE: MK3.0 Male Housing Dual Row	DRAWN: TLX 2020.04.08		KONNRA 东莞市康瑞电子有限公司 DongGuan Konnra Electronics Co., Ltd.		
		Uniformly arrange the drawings	Arvin	2021.09.24	X. X ±0.30		CHECKED:				
		Change the part number and frame format	TLX	2020.04.08	X. XX ±0.20		APPROVED:	PART NO. : H3000M****01A			
	MARK	REVISION DESCRIPTION	SIGNATURE	DATE	X. XXX ±0.10		UNIT: mm	SCALE: N/A	SHEET: 1/2	PROJECTION 	REV. : A5
	1	2	3	4		5	6	7	8	9	