

RoHS
COMPLIANT

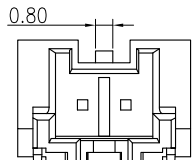

2P View

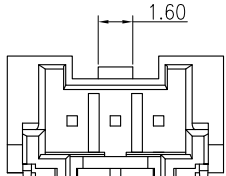

3P View

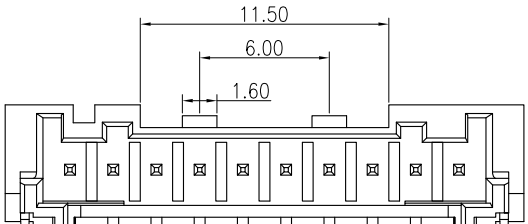

10-15P Two Buckle View

◆ SPECIFICATIONS

- Current rating: 3A (AWG #24)AC, DC
- Voltage rating: 250V AC,DC
- Temperature range: -40°C ~ +105°C
- Insulation resistance: 1000MΩ Min.
- Withstanding voltage: 800V AC/ minute.
- Contact resistance: 20mΩ Max.

Material:

Insulator: Nylon 9T UL 94V-0

Pin: Brass

Plating: Tin plated over Nickel

Suitable: KR2014 series Housing

PART NO: C2014RS1**11M0102RA

02: 2P
16: 16P
11: PA9T NATURAL
M01: Matte Tin

R: REEL
P: BAG

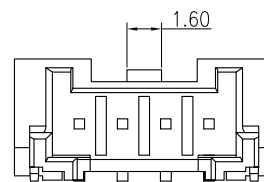
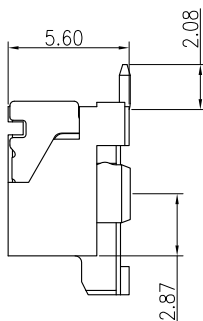
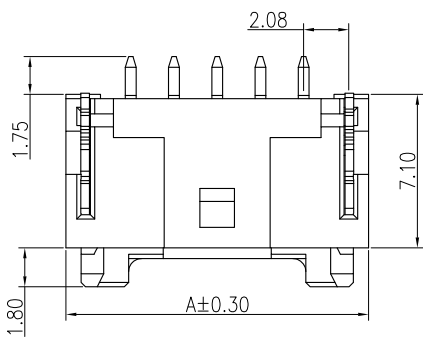

4P View

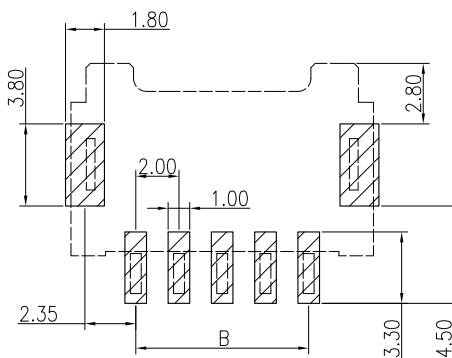
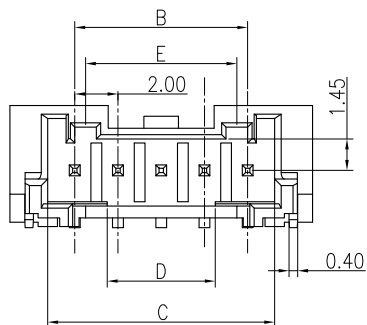

Recommended P.C.B. Layout
Total tolerance: ±0.05mm

15P	34.00	28.00	30.50	23.00	13.60
14P	32.00	26.00	28.50	21.00	13.60
13P	30.00	24.00	26.50	19.00	13.60
12P	28.00	22.00	24.50	17.00	13.60
11P	26.00	20.00	22.50	15.00	13.60
10P	24.00	18.00	20.50	13.00	13.60
9P	22.00	16.00	18.50	11.00	7.00
8P	20.00	14.00	16.50	9.00	7.00
7P	18.00	12.00	14.50	7.00	7.00
6P	16.00	10.00	12.50	5.00	7.00
5P	14.00	8.00	10.50	5.00	7.00
4P	12.00	6.00	8.50	5.00	—
3P	10.00	4.00	6.50	1.00	—
2P	8.00	2.00	4.50	—	—
PIN	A	B	C	D	E

MARK	REVISION	DESCRIPTION	SIGNATURE	DATE
A3	1	Uniformly arrange the drawings	Shen	2021.9.23
A2	2	Change the part number and frame format	Ru yi	2020.3.10

TOLERANCE	TITLE:
X.X ±0.30	PA2.0 SMT 90° WF B TYPE
X.XX ±0.25	
X.XXX ±0.10	
Angle ±2°	
UNIT:mm	SCALE:1/1

DRAWN: Shen 2021.09.23
CHECKED:
APPROVED:
SHEET:1/1
PROJECTION

KONNRA 东莞市康瑞电子有限公司 DongGuan Konnra Electronics Co.,Ltd.	
PART NO.: C2014RS1**11M0102*A	
REV.:A3	DRAWING NO.:2014WFHS01-A-S